

COMMERCIAL BROCHURE

SPRING 2026



DESIGN:
THERMALEX - MODEL TX450



upwardor

Garage Doors Designed for Life

Table Of Contents

3 **THERMALEX**®
Overhead Door

4 **SOLALITE**™
Translucent Aluminum
Overhead Doors

5 **AL-SWD**™
Aluminum Slim
Window Design

6 **AL-976**™
Aluminum Full View

7 **PANORAMA**

8 **TRACK & HARDWARE**

9 **ICONTROLS**

11 **LIFTMASTER**

13 **POWAIRDOR**™
PowAirDor Pneumatic Door Operator



Commercial Door Systems



Commercial Line



THERMALEX®

SOLALITE™

AL-SWD™

AL-976™

POWAIRDOR™

Thermalex



The Complete Solution for Quality, Versatility and Energy Efficiency

The Thermalex® Series from Upwardor® is a line of sectional overhead doors specifically designed for commercial and industrial applications. They're built to last and their superior quality provides high levels of thermal efficiency making them the ideal choice for any sectional overhead door application.

TX380 MODEL

- R-Value 14.1 Single Continuous 1-1/4" 20ga Strip
- 1 1/2" Thick Insulated Panel
- Thermal Break
- UDC Groove
- 5 Year Ltd Warranty

TX450 & 450-20 MODEL

- R-Value 16.3 Two Continuous 1-1/4" 20ga Strip
- 1 3/4" Thick Insulated Panel
- Thermal Break
- Windload
- UDC Groove
- 10 Year Ltd Warranty
- IECC Certified

TX500 & TX500-20 MODEL

- R-Value 18.4 Two Continuous 1-1/4" 20ga Strip
- 2" Thick Insulated Panel
- Thermal Break
- Windload
- UDC Groove
- 10 Year Ltd Warranty
- IECC Certified

TX760 MODEL

- R-Value 27.7 Two Continuous 3" 20ga Strip
- 3" Thick Insulated Panel
- Thermal Break
- Micro Groove
- 10 Year Ltd Warranty

TX760 3" (76.2MM)

SIDE VIEW
ILLUSTRATION

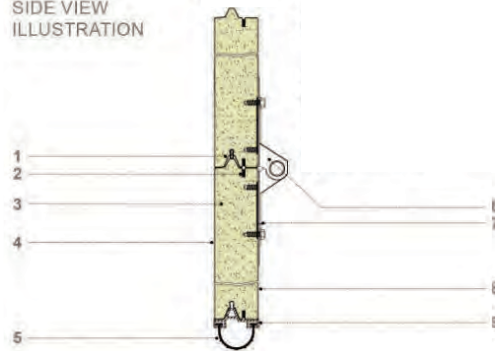

- (1) Low temperature vinyl bulb weather seal
- (2) Thermal break foam tape
- (3) Foamed-in-place polyurethane ozone friendly zero (ODP)
- (4) 26ga exterior prefinished steel skin
- (5) Low temperature vinyl bottom astragal
- (6) Full hinge application
- (7) Hinge/Strut reinforcement steel strips
- (8) Embossed back sheet
- (9) PVC bottom retainer

SERIES TX380

SERIES TX450/TX500

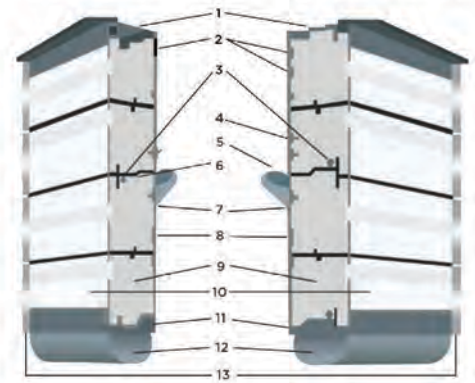

- (1) Low Temp top retainer/seal (Optional)
- (2) 20 ga Continuous steel strip hinge reinforcement
- (3) Dual Contact Weatherseal
- (4) Full Hinge Application TX450/500
- (5) Tongue and Groove Joint
- (6) Shiplap Joint
- (7) Thermal break chemically sealed and bonded
- (8) Interior Steel Stucco Embossed
- (9) Polyurethane Core
- (10) Exterior Steel Stucco Embossed
- (11) PVC Bottom Retainer
- (12) Low temp Vinyl astragal
- (13) Endstile w/ weatherseal

Colour Choices:

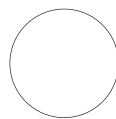

White



Black



New Brown



Steel Grey

For details on warranties, windows & door options, visit upwardor.com

SolaliteTM

Translucent Aluminum Overhead Doors

The Only Door With a Complete Thermal Break and Continuous Hinge

The Solalite door is an exceptional example of innovation and engineering. This door was created for customers who require a product which can withstand demanding, high-cycle applications and is impact, corrosion and moisture-resistant. The Solalite's sleek and contemporary appearance blends with current architectural trends.

ALL WEATHER

Performs in the most challenging weather conditions including cold weather climates.

TOUGH

Resists impact, corrosion and moisture infiltration.

VERSATILE

A smart choice for high-volume applications such as car washes, automotive dealerships, agricultural applications, municipal facilities, underground parking structures and more.

WET ENVIRONMENTS

Optional corrosion-resistant hardware package provides additional protection against harsh environments.

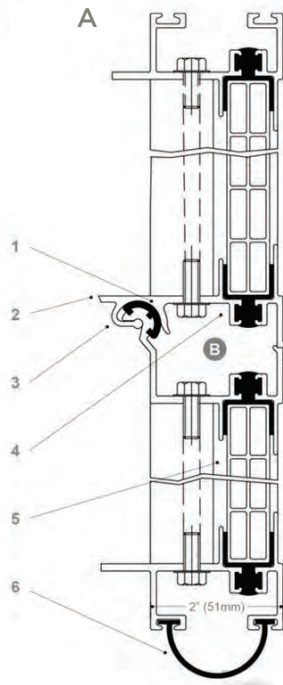

- (1) PVC bushing
- (2) Built-in integral strut
- (3) Continuous hinge extrusion
- (4) Thermally broken frame
- (5) 5/8" (16mm) five wall polycarbonate clear, light bronze or dark bronze
- (6) Low temp vinyl bottom astragal

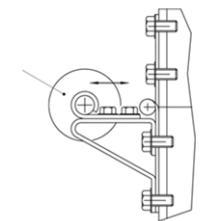

Adjustable Galvanized Hinge

Multiple colour & window options available:



5-year limited warranty on door finish



1-year limited warranty on workmanship & materials



Standard clear anodized finish

Actual door colour may vary from brochure



Sleek, Modern Design, High-Quality, Long Lasting Performance

Ideal for automotive dealerships and similar applications, the AL-SWD outperforms when effective visibility and light transmission are required. A high-quality, distinctive design provides an affordable alternative to a high-speed roll-up door. The AL-SWD is manufactured using the highest-grade aluminum extrusions, thereby reducing stress on all moving parts of the door for longevity in a high cycle environment.

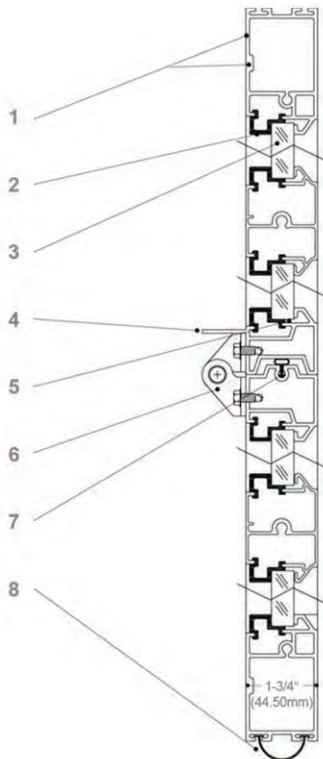

- (1) .070" (1.78mm) typical, .115" (2.92mm) at attachments
- (2) Glazing molding
- (3) Glazing
- (4) Reinforcing strut (optional under 16' [4.88m])
- (5) Soft vinyl glazing bead
- (6) Centre hinge
- (7) Weatherseal
- (8) Low temp. vinyl astragal



Multiple colour & window options available:

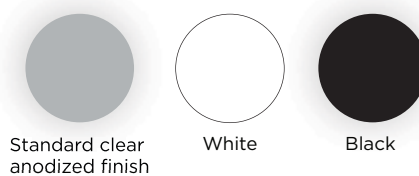

Actual door colour may vary from brochure

CONSTRUCTION

1-3/4" (44.50mm) thickness manufactured from extruded 6063-T6 Aluminum.

WINDOW OPTIONS

Various glazing options available; single glass, plexi, polycarbonate or stucco panel.

LARGE DOORS

Available up to 24' (7.32m) wide.

COST SAVINGS

Comparable looking to roll-up versions that cost up to 3X more and have more moving parts that can break down, costing in downtime and large financial costs.



5-year limited warranty
on door finish



1-year limited warranty
on workmanship & materials



AL-976™

Aluminum Full View

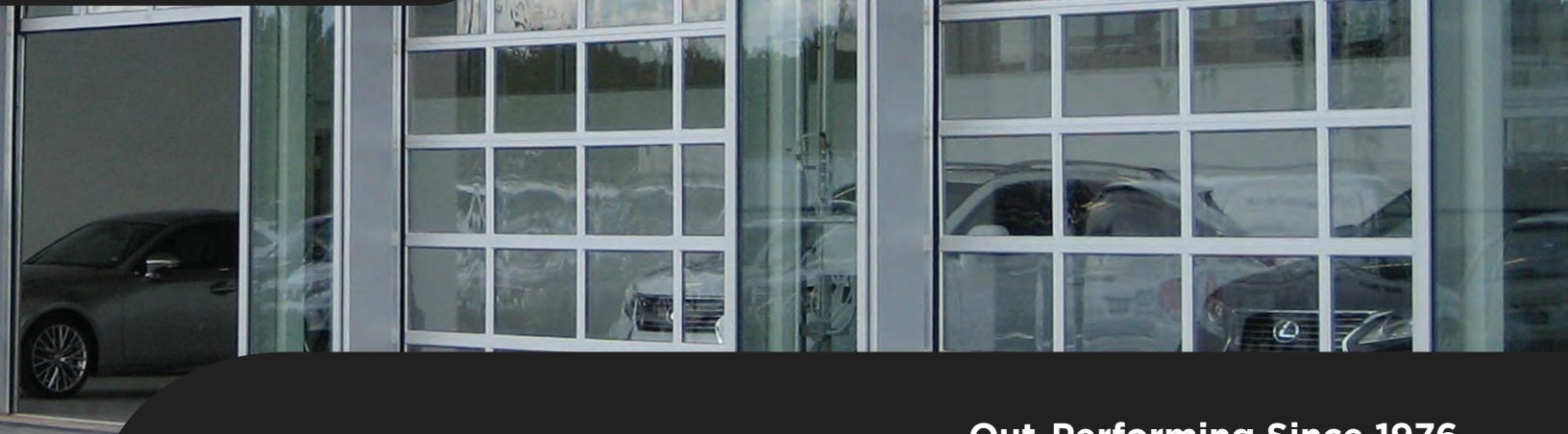

Out-Performing Since 1976

Manufactured since 1976, the AL-976 aluminum door offers a variety of options where superior strength, maximum visibility and exceptional light transmission are required. Its unique and durable design allows customized configurations for openings up to 24' (7.32m) and complements the exterior of any facility.

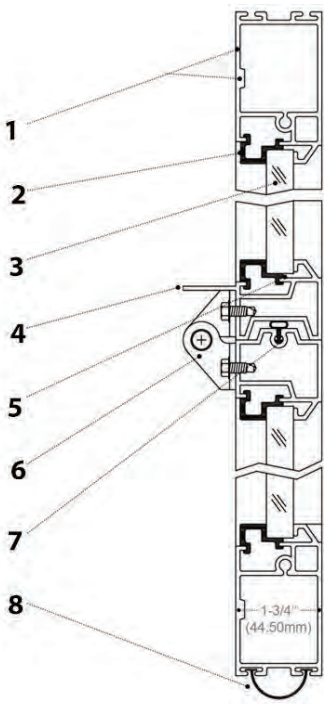

- (1) .070" (1.78mm) typical,
Multiple Colour Selections
.115" (2.92mm) at attachments
- (2) Glazing molding
- (3) Glazing
- (4) Reinforcing strut (optional
under 16' [4.88m])
- (5) Soft vinyl glazing bead
- (6) Centre hinge
- (7) Weatherseal
- (8) Low temp. vinyl astragal



Available with various glazing options: single, insulated, tinted, tempered or specialty.



Solid bottom options: Stucco panel, anti-dent panel or Thermalex® panel to match.

Multiple colour & window options available:



Standard clear anodized finish

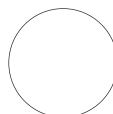

White



Black

Actual door colour may vary from brochure



5-year limited warranty
on door finish



1-year limited warranty
on workmanship & materials

PANORAMA™

Aluminum Full View

Panorama: Engineered Transparency

Experience expansive light with Panorama aluminum doors. Engineered with 1-3/4" aluminum frames and virtually unbreakable polycarbonate glazing, which is crafted as one continuous piece. These doors feature weather seals and customizable finishes.

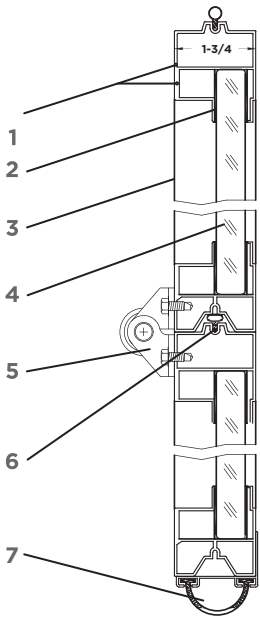

- (1) 0.058" (1.47mm) through extrusion, 0.104" (2.64mm) at attachments
- (2) 3/32" x 1-3/4" Polyethylene foam tape
- (3) Centre stile not visible from exterior, provides full view concept
- (4) 5/8" (16mm) five wall polycarbonate clear, light bronze or dark bronze
- (5) Centre hinge
- (6) Weatherseal
- (7) Low temp. vinyl astragal

Multiple colour & window options available:



Standard clear anodized finish

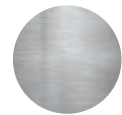

Mill Finish



Black

Actual door colour may vary from brochure



5-year limited warranty
on door finish



1-year limited warranty
on workmanship & materials



Track and Hardware

In addition to manufacturing door panels, Upwardor's manufacturing facility also houses a full range of roll forming stamping machinery and equipment for fabrication of hardware and accessories (including tracks, angle, brackets, hinges, and end caps). All components are manufactured to industrial-grade specifications.

Of all the components in our doors, 90% are manufactured by Upwardor. This allows us to maintain competitive pricing, supply the product on short lead-times and supply all of our dealers with bulk quantities or replacement parts.

Key Features & Benefits:

- Heavy-duty industrial material is used in the manufacturing process
- In-house manufacturing capabilities minimize lead times
- One-stop-shopping makes ordering easy and allows dealers to enjoy freight economies
- Commercial hardware is specifically designed for Upwardor products but, in most cases, it can also be used with other manufacturers' components



Specific Items Available in Bulk:

- 2" (50.8mm) and 3" (76.2mm) Track: vertical & horizontal — raw or assembled.
- Track bracket and reverse-angle for vertical track
- Horizontal angle
- 2" (50.8mm) 18-gauge and 16-gauge struts
- 16-gauge and 20-gauge end stiles
- Nystroll Rollers
- Hinges, rollers, head plates, spring assemblies, etc.
- Top brackets, shelf brackets
- Side locks

For details on all our Track and Hardware, visit upwardor.com for our full catalogue





PULSE Series

Pulse operators are designed to meet the demands of high performance and cost efficiency in commercial applications. These DC direct-drive operators feature advanced speed control (up to 24"/s open, 16"/s close), soft start/stop functionality, programmable closing timers, and a built-in battery backup for reliable operation even during power outages. Additional features include adjustable force monitoring, a precise position encoder, an integrated door balance check, and a backlit LCD for simplified setup and troubleshooting. Compatible with 1" or 1-1/4" shafts and available in various horsepower and gearbox configurations, Pulse delivers powerful performance and streamlined installation. UL 325:2023 listed and backed by a 2-year warranty, Pulse is built to last.

Exceptional Standard Features

- Built-in Battery Backup
- Adjustable Force monitoring on Open and Close cycles
- Programmable Speeds up to 24"/s
- Soft Start/Soft Stop
- Integrated Door Balance Check
- 2-Year Warranty
- Programmable output relay



To view more of our iControls products, visit [upwardor.com](https://www.upwardor.com)



Selection Guide

PULSE 100 Series

- Available in 3/8 HP and 1/2 HP for 1" or 1-1/4" solid shafts
- 2-year, 500,000-cycle warranty against manufacturing defects
- Advanced speed control: up to 24"/s opening, up to 16"/s closing
- Built-in 24V, 0.8Ah battery backup



PULSE 200 Series

- Motor options: 3/8, 1/2 HP; gearbox ratios: 30:1, 40:1 and 50:1
- 2-year, 250,000-cycle warranty against manufacturing defects
- Advanced speed control: up to 24"/s opening, up to 16"/s closing
- Built-in 24V, 2.3Ah battery backup



PULSE 300 Series

- Motor options: 1/2, 3/4, 1HP; gearbox ratios: 30:1, 40:1, 50:1 and 60:1
- 2-year, 1-million-cycle warranty against manufacturing defects
- Advanced speed control: up to 24"/s opening, up to 16"/s closing
- Built-in 24V, 9Ah battery backup





Medium Duty, HeavyDuty, Industrial Duty Operators

LiftMaster's® Custom Solutions are integrated packages, assuring seamless integration of a motorized Commercial Door System. The combination of advanced technology, features and accessories provided by LiftMaster simplifies the process of determining the best solution to meet your specific automatic door operator application.

Key Features & Benefits:

- Business Safety and Security
- Security+®
- Meets UL 325 Safety Standards
- Commercial Safety Sensors
- Protect people and vehicles with safety sensors and accessories that stop the door from closing on obstructions
- Timer to close
- Integrated timer-to-close programmable from 5 to 60 seconds in 5-second increments. Allows for timed automatic door enclosure after the door reaches the full open position.



For details on all our Commercial Liftmasters, visit upwardor.com for our full catalogue

LiftMaster

As the leader in residential and commercial access, LiftMaster designs and delivers the safest, smartest door and gate solutions to keep everyone moving forward. From the products we create to how they're installed and used. Our professional installers make sure that you have a reliable product that works perfectly—letting you live your life hassle-free.

No matter the type of door you have, LiftMaster commercial door operators will keep it in operation safely and efficiently so your business can keep running smoothly.

LiftMaster commercial door operators are highly customizable, so they can be modified to excel in any environment. Check out our business solutions to see how we can help business run like a well-oiled machine.

Commercial Accessories

Single Button Control

- Single button control provides an additional input for single-button control functionality. Required for installation of any external radio receiver.

Auxilliary Limit Switches

- Auxilliary limit switches provide additional limit switch with dry form C contracts at the open and closed door positions to control lights, heaters and dock levelers.

Interlock Switch

- Interlock switch disables the operator control circuit when door is locked, preventing damage to the door and operator.

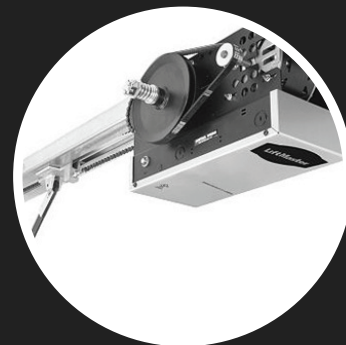

POWAIRDOR™

Door Operator
PowAirDor Pneumatic

PowAirDor: The Maintenance-Free Solution for High-Cycle Doors

The PowAirDor has only one moving part and is virtually maintenance-free. Created specifically for ultra-high-cycle, high corrosion applications and adaptable to any door, the PowAirDor product has been proven to last for decades, while out-performing other manufacturers' operators.

NO CABLE JUMPING!

Drives the door not the shaft

LOW MAINTENANCE

Only 1 moving part

HIGH SPEED!

Adjustable up to 45" per second

HIGH CYCLE

& corrosion applications

ALL CLIMATES

Works in cold & hot climates



PA 17 Series

Control panel paired with a rodless pneumatic cylinder which has only one moving part and directly connects to the door without chains, belts, pulleys or sprockets. This allows continuous, flawless operation without having to worry about cables coming off the door or a multitude of service parts with the potential to fail.

Easy Programming, easier to program than a standard jack-shaft garage door. Simple, easy-to-use LCD screen with the option of changing the use of a sensor from safety to activation without opening the panel. Operates on 24v and easy valve adjustable speed controls. Wide assortment of Safeties and Activations.



For details on warranties, windows & door options visit upwardor.com

TURN ANY SECTIONAL DOOR INTO A HIGH SPEED DOOR!

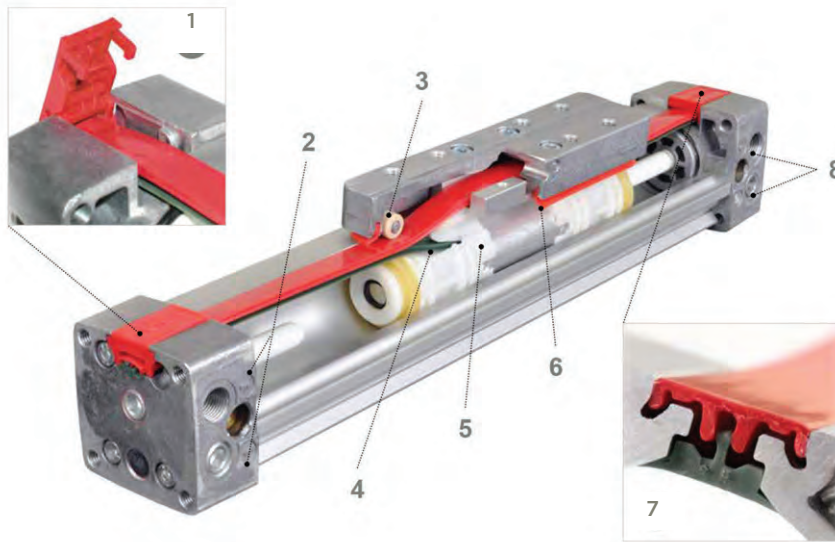

- (1) Patented retainers require no tools for replacement
- (2) Port identification clearly identifies carriage direction
- (3) Roller closer mechanism reduces friction in the carriage assembly providing smoother movement
- (4) Advanced strip divider improves running performance
- (5) Integral wear ring provides additional support and increased load carrying capacity
- (6) Improved wiper seal design prevents dust ingress ensuring smoother operation and increased cylinder life
- (7) Patented sealing system uses an interlocking seal to prevent dust ingress increasing cylinder life
- (8) Multiple porting

CAR TRUCK WASH APPLICATIONS



Car Wash PA15 series

Control panel paired with a rodless pneumatic cylinder which has only one moving part and directly connects to the door without chains, belts, pulleys or sprockets. This allows continuous, flawless operation without having to worry about cables coming off the door or a multitude of service parts with the potential to fail.

RELIABLE

With only one moving part and simple controls designed around most car wash requirements, the PA15 series pneumatic door operator will give you peace of mind in your investment.

PROVEN PERFORMANCE

Since 1990 POWAIRDOR™ has been setting the bar for quality across the industry. Safe and efficient travel speeds of up to 42" per second decreases the time for a vehicle wash cycle while also increasing your savings on heating costs.

SAFE

Every control panel features IP67 through beam safety photo eyes mounted at the door opening with an integrated "Fail Safe" circuit to insure the utmost safety, all of the time. Cover mounted push buttons open and close the door pneumatically allowing manual operation, even when there's no power.



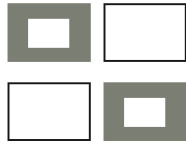

upwardor

Garage Doors Designed for Life

1-800-667-3367

T: 905-876-3667

F: 905-876-3533

sales@upwardor.com

Milton, ON

